

# TB200

Frequency=20-1000MHz

Pout=60W

Gain=10dB

Vds=28.0Vdc

Idq=1.0A

LB401

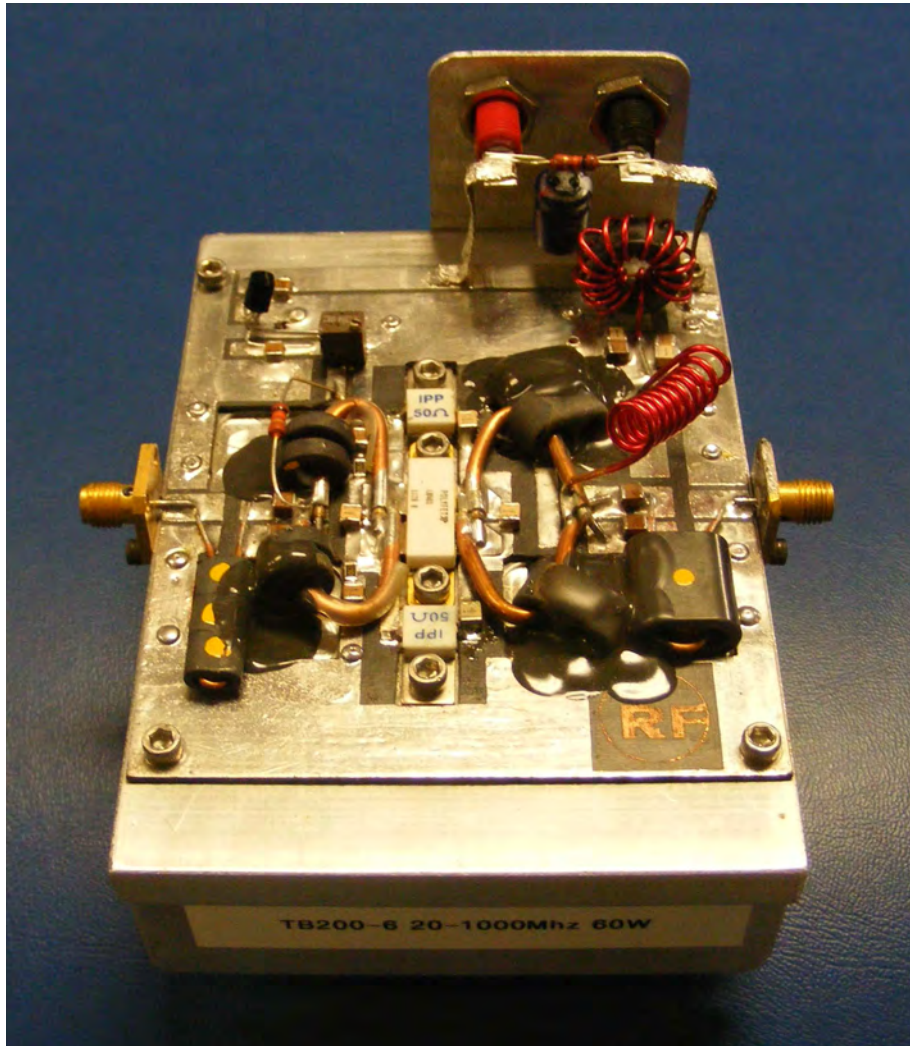

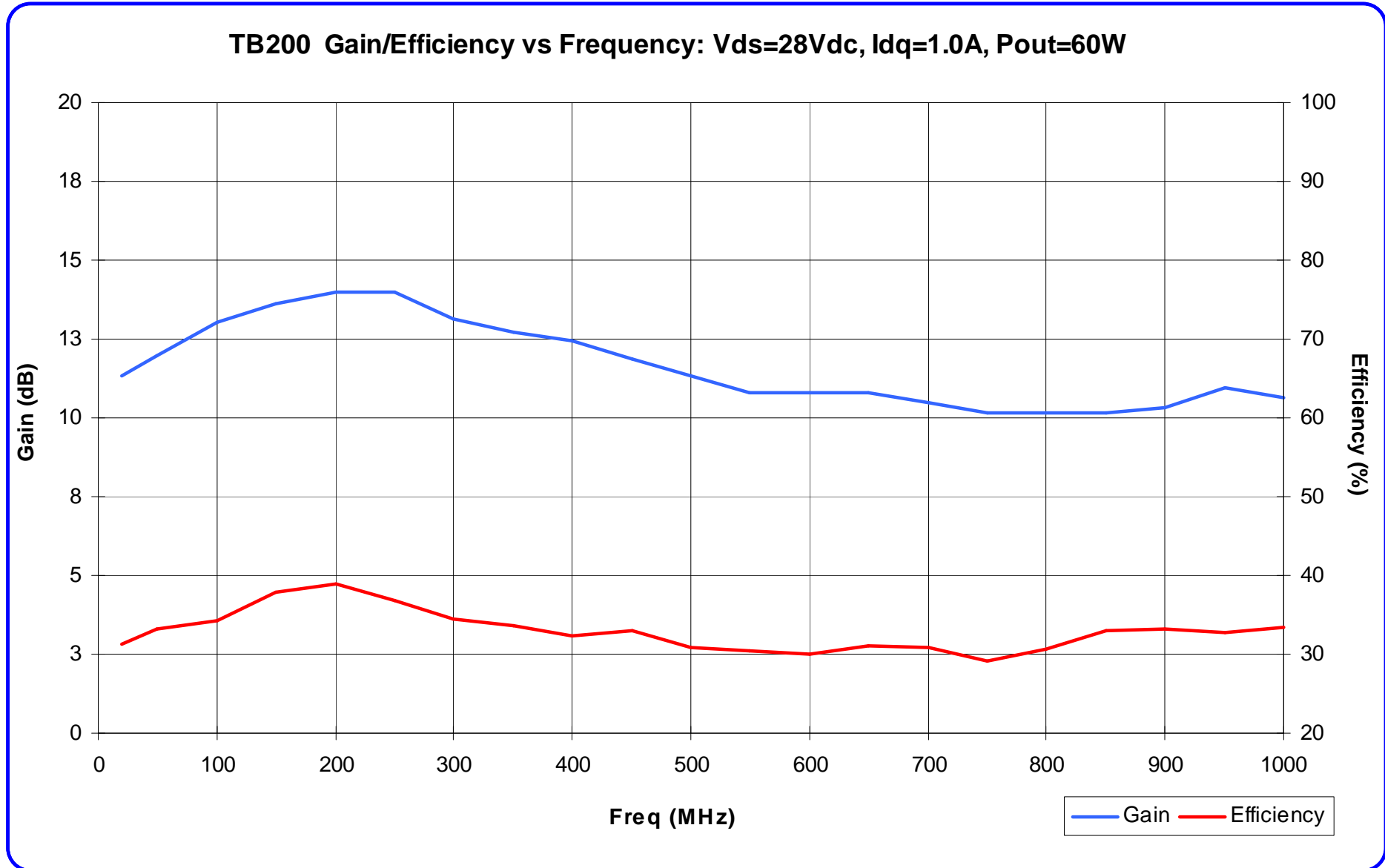

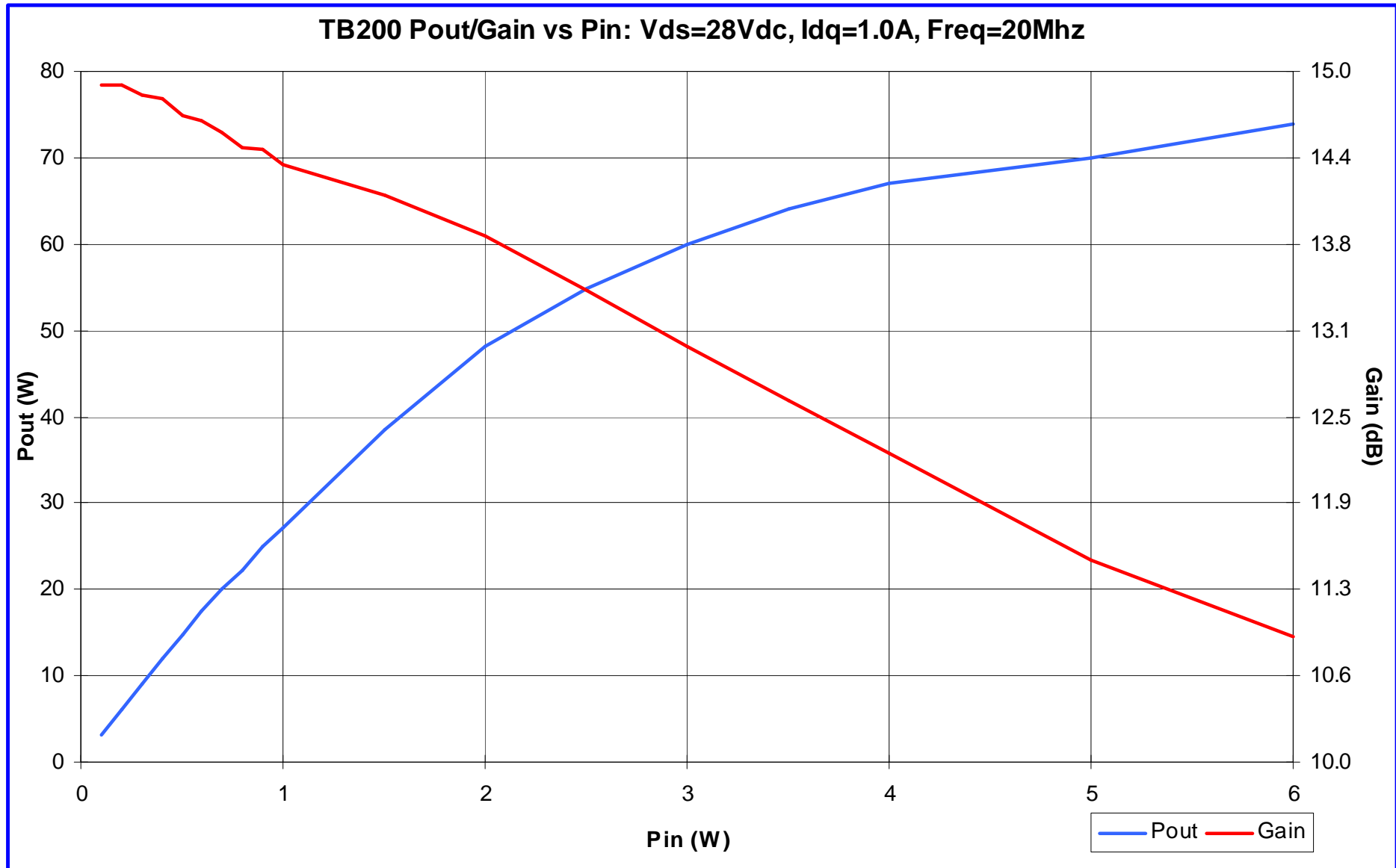

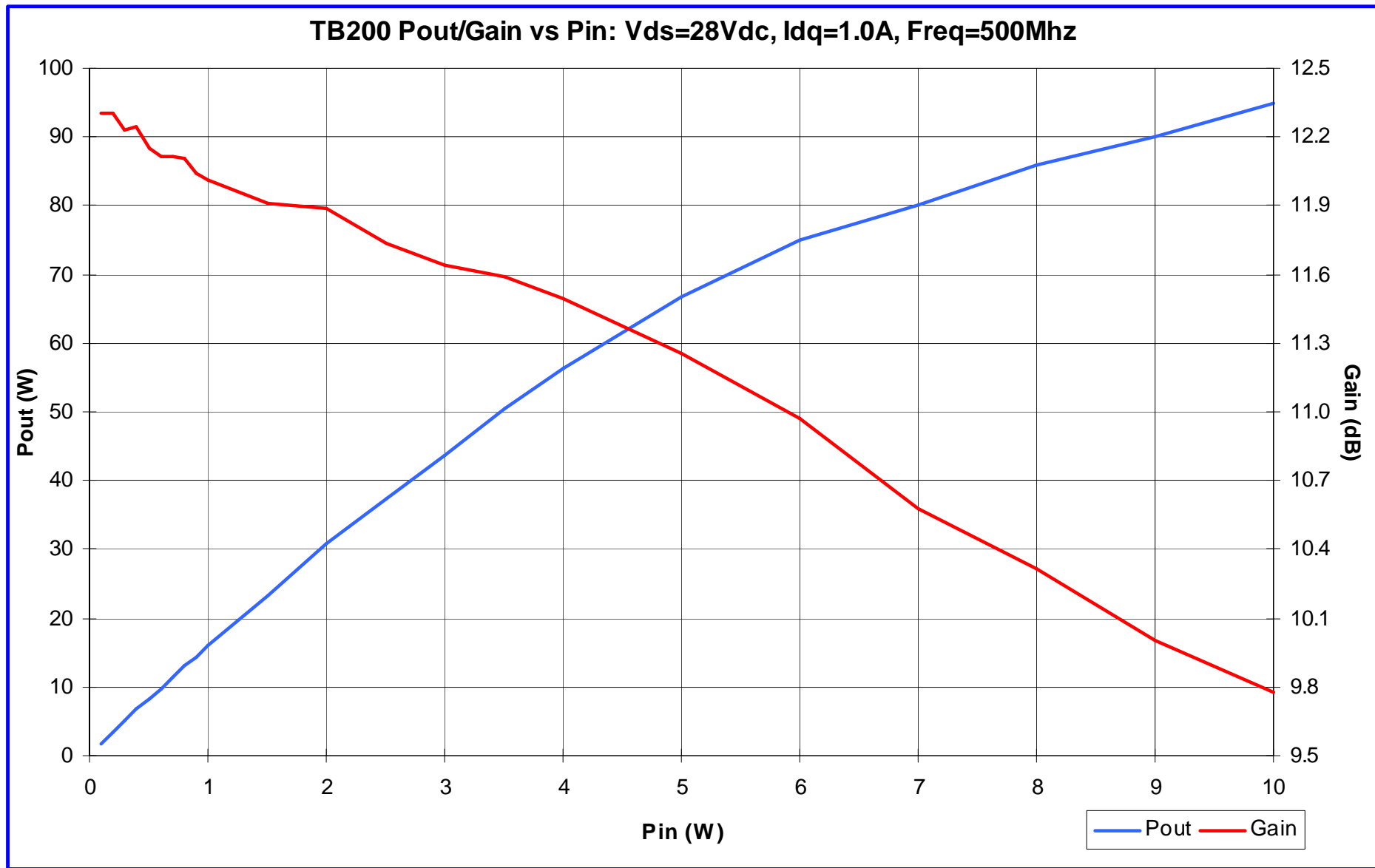

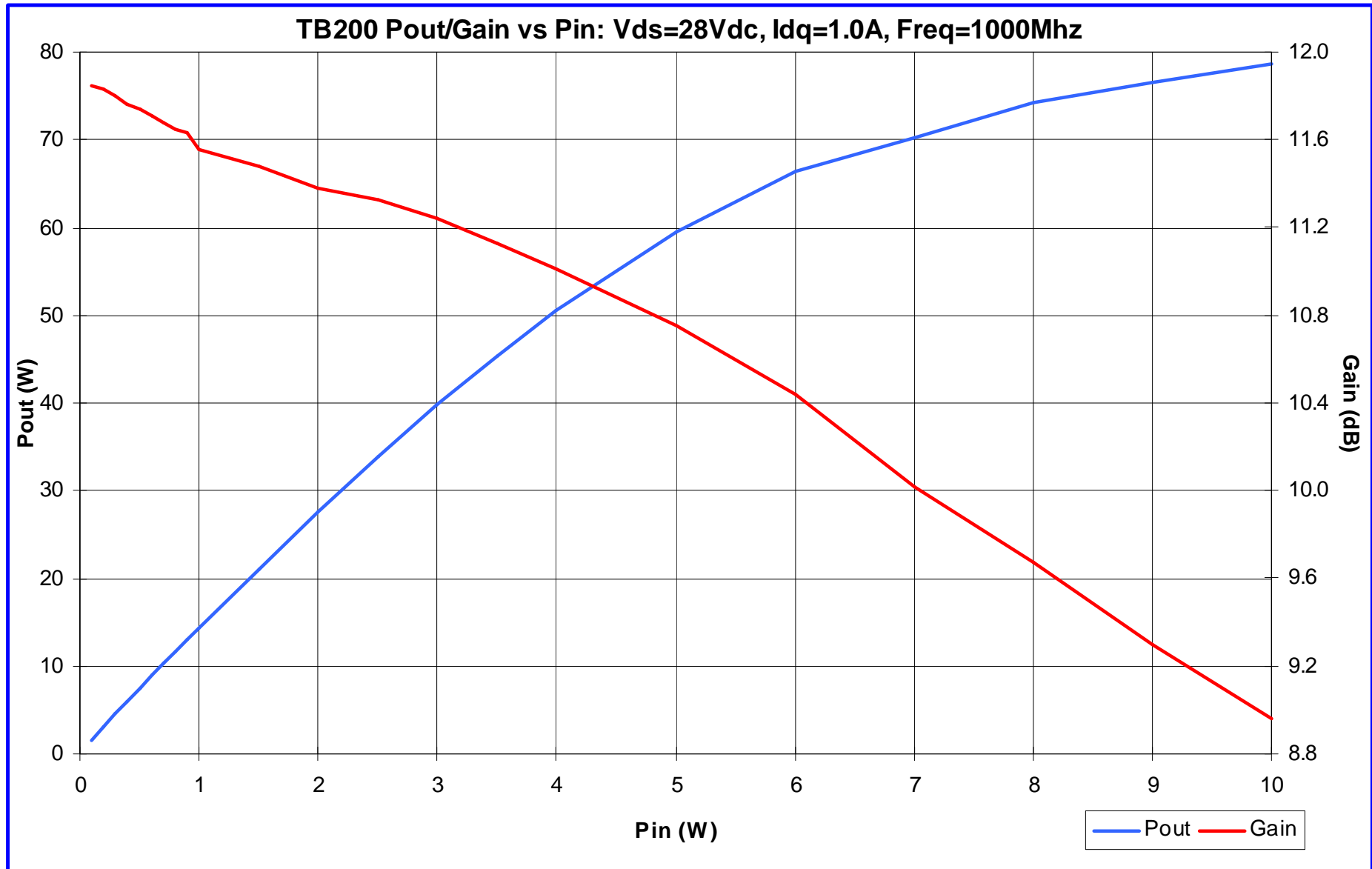

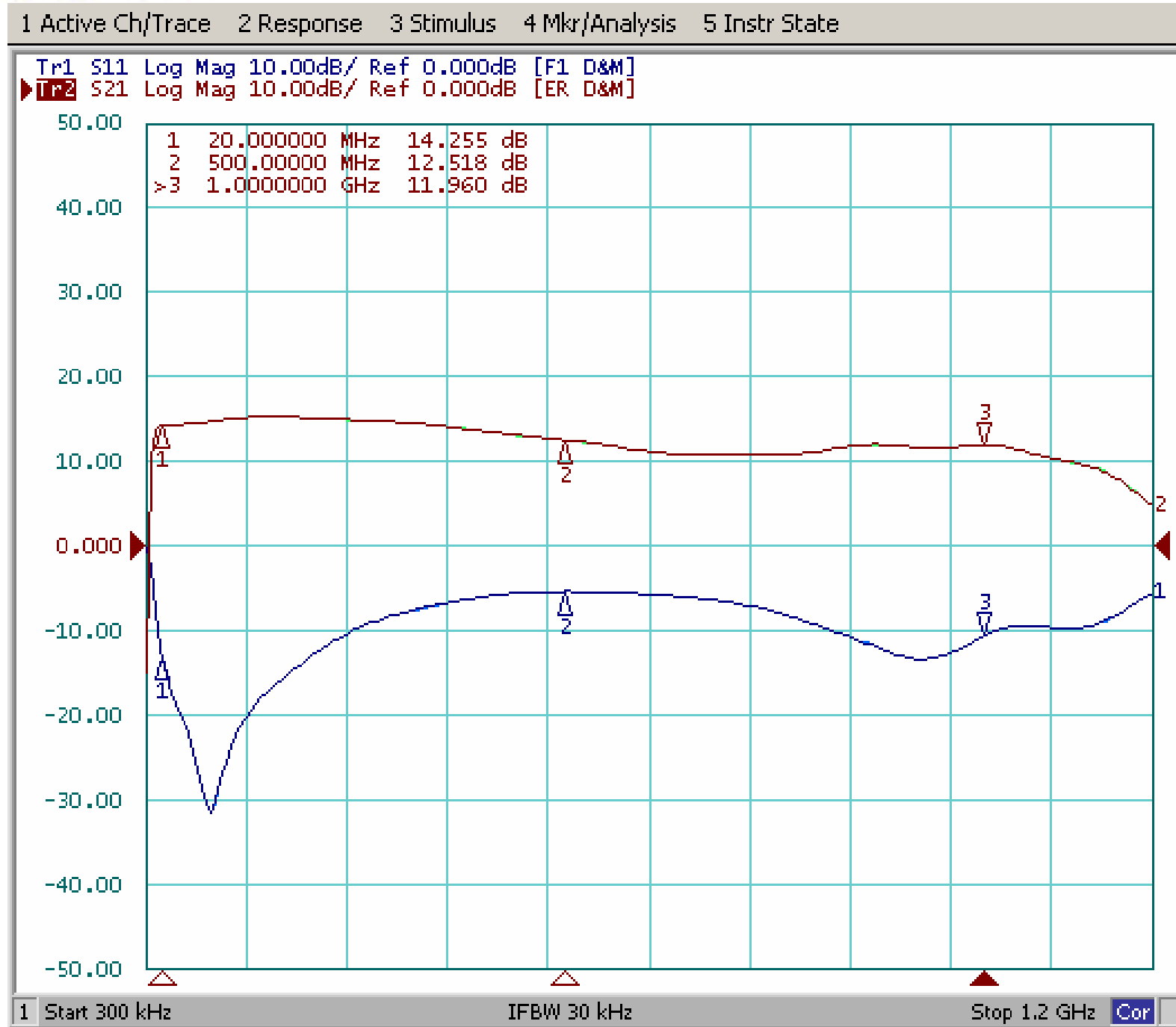

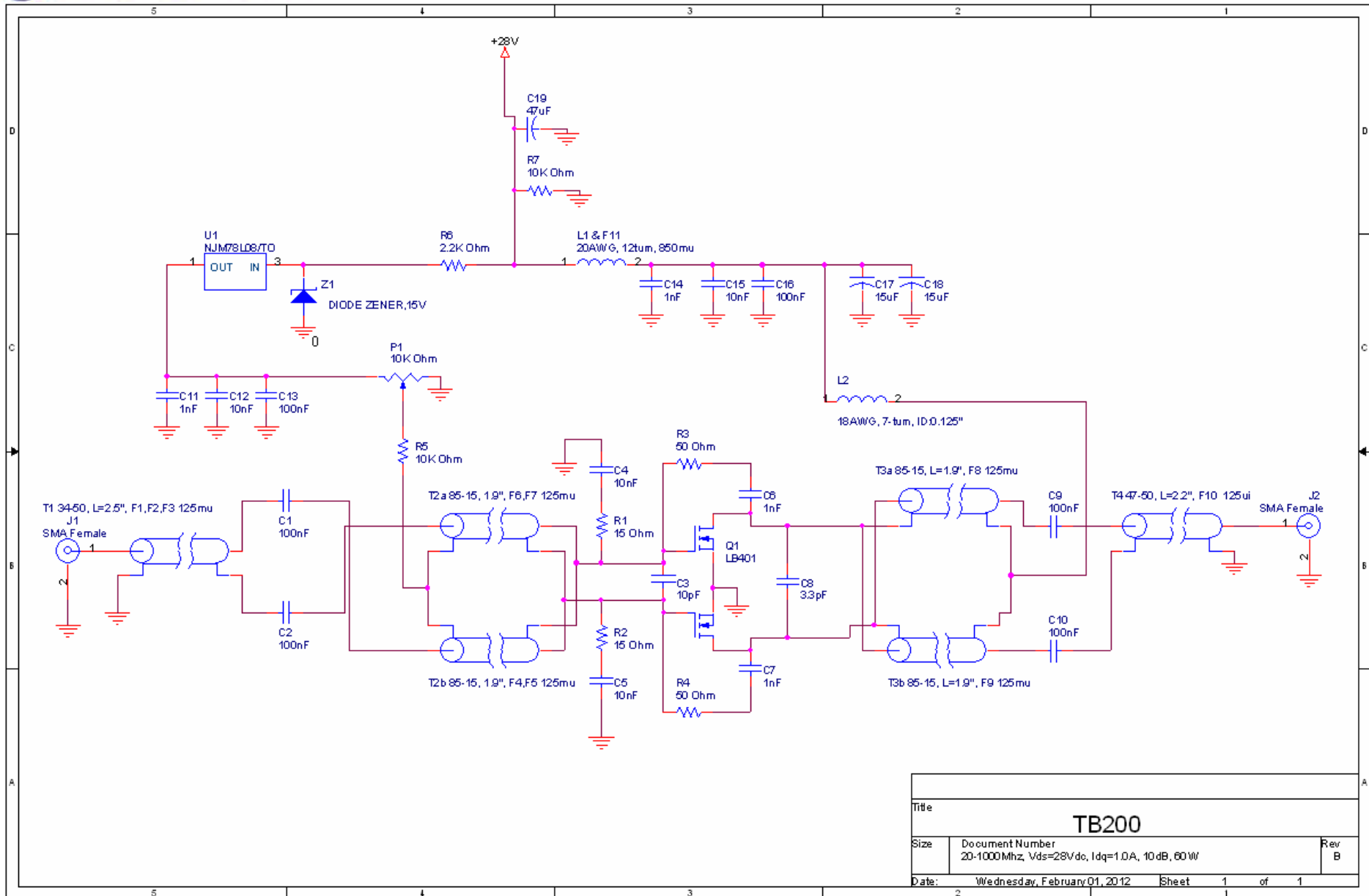

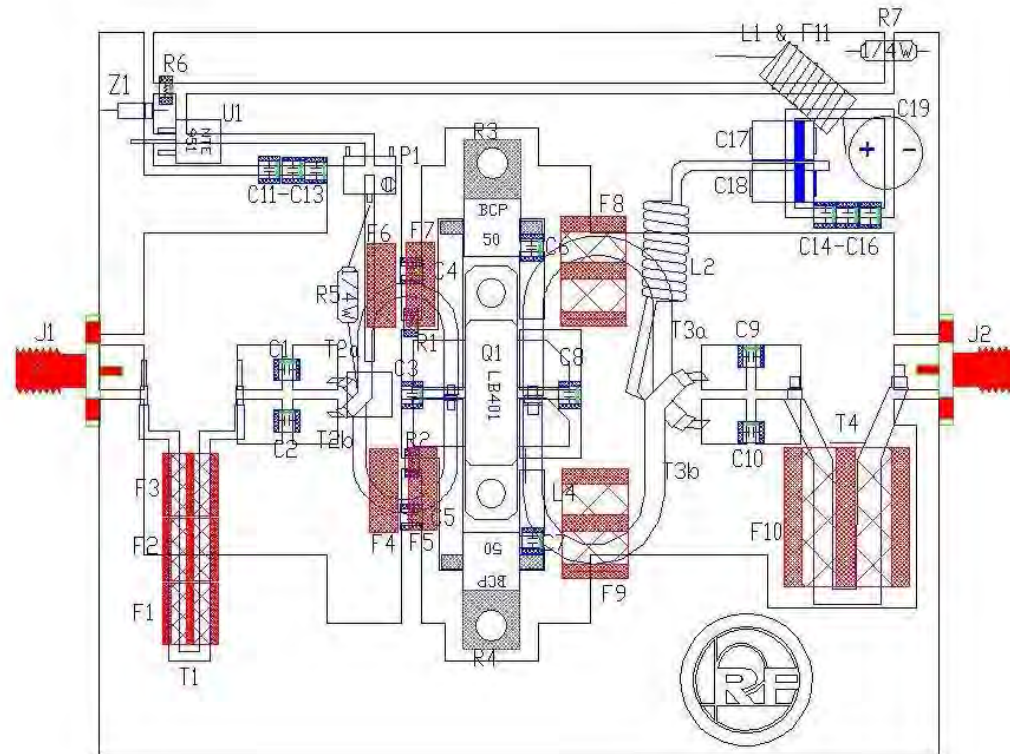

DRN BY: M. Cervantes	01/31/12	POLYFET RF DEVICES			
CHKD BY: M. Cervantes	01/31/12				
ELECT BY: J. Citrola	08/24/11	TB200 LB401 20-1000MHz 60W 10dB			
MECH BY: J. Urbina	08/24/11				
PROC :		SIZE	FSCM NO	Vdd=28V Idq=1.0A	REV B
QUAL :		SCALE : 1 : 1		SHEET 1 OF 1	
PGMS :					



NOMENCLATURE	DESCRIPTION	VENDER	VENDER PART #
C1,C2,C9,C10,C13,C16	100nF Ceramic Multilayer Capacitor	ATC	200B104KW50X
C3	10pF Porcelain Superchip Multilayer Capacitor	ATC	100B100GW500X
C4,C5,C12,C15	10nF Ceramic Multilayer Capacitor	ATC	200B103KW50X
C6,C7,C11,C14	1nF Porcelain Superchip Multilayer Capacitor	ATC	100B102JW50X
C8	3.3pF Superchip Multilayer Capacitor	ATC	100B3R3BW500X
C17,C18	15uF 50V 10% Kemet SMD Tantalum Chip Cap.	Mouser Electronics	80-T491X156K050
C19	47uF Aluminum Electrolytic, 35V	Digi-Key	PCE3735CT-ND
L1	Magnet Wire,20AWG, 12-turns around F11	www.electromechaniconline.com	MW200SPNRD
L2	Magnet Wire,18AWG, 7-turns I.D.=0.125",Aircoil	www.electromechaniconline.com	MW180SPNRD
R1,R2	RES 15.0 OHM 1/4W 1% 1206 SMD	Digi-Key	RHM15.0FCT-ND
R3, R4	RES 50 ohms, 50Watts, DC-4.2Ghz	IPP	IPP-RB203-50
R5	RES 10K OHM METAL FILM 1W 5%	Digi-Key	PPC10KW-1CT-ND
R6	RES 2.2K OHM 1/4W 5% 1206 SMD	Digi-Key	RHM2.2KECT-ND
R7	RES 10K OHM 1/4W 5% 1206 SMD	Digi-Key	RHM10KERCT-ND
U1	IC 8V POS-VOLT REG TO-92-3	Digi-Key	296-11124-5-ND
P1	Trimmer Resistors - SMD 1/4 10Kohms 10%	Mouser Electronics	652-3269W-1-103GLF
T1	Semi-Rigid Coaxial Cable, Length=2.5"	Amawave	UT-034C-50
T2a,T2b	Semi-Rigid Coaxial Cable, Length=1.9"	Amawave	UT-085C-15
T3a,T3b	Semi-Rigid Coaxial Cable, Length=1.9"	Amawave	UT-085C-15
T4	Semi-Rigid Coaxial Cable, Length=2.2"	Amawave	UT-047C-50
F1-F3	125ui, Multi-Aperture Core	Amidon	BN-61-2402
F4-F7	125ui, Toroid	Amidon	FT-37-61
F8-F9	125ui, Multi-Aperture Core	Amidon	2861001502
F10	125ui, Multi-Aperture Core	Amidon	BN-61-202
F11	850ui Toroid	Amidon	FT-50-43
Z1	DIODE ZENER 500MW 15V MINIMELF	Digi-Key	BZV55C15-TPMSCT-ND
Q1	LDMOS	Polyfet RF Devices	LB401
J1,J2	SMA Female; 4 Hole Panel Mount	Pasternack	PE4000-SF
PCB	PTFE/woven glass Er=2.45- 2.65, 30mil 2oz/2oz copper	Taconic	TLX-9-0300-C2/C2